

# PA52 • PA52A

## FEATURES

- HIGH INTERNAL DISSIPATION — 400 Watts
- HIGH CURRENT — 40A Continuous, 80A PEAK
- HIGH SLEW RATE — 50V/ $\mu$ s
- OPTIONAL BOOST VOLTAGE INPUTS

## APPLICATIONS

- SEMI-CONDUCTOR TESTING

## DESCRIPTION

The PA52 is a MOSFET power operational amplifier that extends the performance limits of power amplifiers in slew rate and power bandwidth, while maintaining high current and power dissipation ratings.

Boost voltage inputs allow the small signal portion of the amplifier to operate at a higher voltage than the high current output stage. The amplifier is then biased to achieve close linear swings to the supply rails at high currents for extra efficient operation.

## EQUIVALENT SCHEMATIC

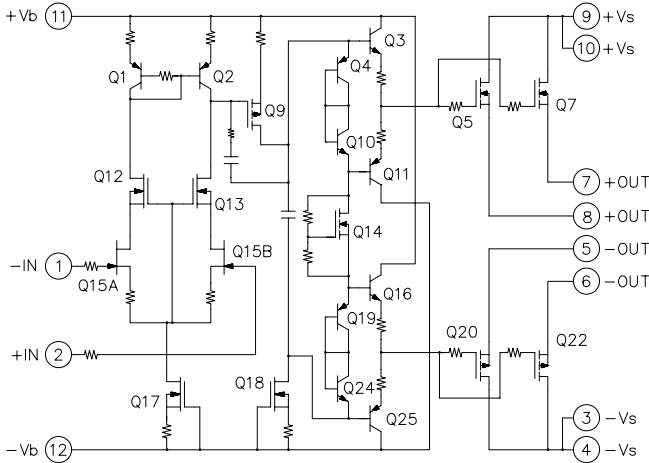

**12-PIN DIP  
PACKAGE STYLE CR**

The JEDEC MO-127 12-pin Power Dip™ package (see Package Outlines) is hermetically sealed and isolated from the internal circuits. The use of compressible thermal washers and/or improper mounting torque will void the product warranty. Please see “General Operating Considerations”.

## EXTERNAL CONNECTIONS

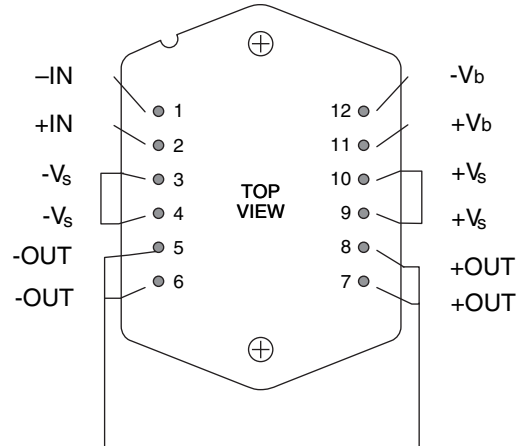

# PA52 • PA52A

## ABSOLUTE MAXIMUM RATINGS SPECIFICATIONS

### ABSOLUTE MAXIMUM RATINGS

|                                    |               |
|------------------------------------|---------------|
| SUPPLY VOLTAGE, $+V_S$ to $-V_S$   | 200V          |
| BOOST VOLTAGE, $+V_b$ to $-V_b$    | 230V          |
| OUTPUT CURRENT, within SOA         | 80A           |
| POWER DISSIPATION, internal        | 400W          |
| INPUT VOLTAGE, differential        | $\pm 20V$     |
| INPUT VOLTAGE, common mode         | $\pm V_b$     |
| TEMPERATURE, pin solder - 10s      | 300°C         |
| TEMPERATURE, junction <sup>2</sup> | 150°C         |
| TEMPERATURE, storage               | -65 to +150°C |
| OPERATING TEMPERATURE RANGE, case  | -55 to +125°C |

### SPECIFICATIONS

| PARAMETER                                     | TEST CONDITIONS <sup>1</sup>   | PA52                       |                   |                   | PA52A             |     |     | UNITS            |
|---|--|----------------------------|-------------------|-------------------|-------------------|-----|-----|------------------|
|   |  | MIN                        | TYP               | MAX               | MIN               | TYP | MAX |                  |
| <b>INPUT</b>                                  |  |                            |                   |                   |                   |     |     |                  |
| OFFSET VOLTAGE, initial                       |  |                            | 5                 | 10                |                   | 2   | 5   | mV               |
| OFFSET VOLTAGE, vs. temperature               | Full temperature range   |                            | 20                | 50                |                   | *   | *   | $\mu V/^\circ C$ |
| OFFSET VOLTAGE, vs. supply                    |  |                            | 10                | 30                |                   | *   | *   | $\mu V/V$        |
| BIAS CURRENT, initial                         |  |                            | 10                | 50                |                   | *   | *   | pA               |
| BIAS CURRENT vs. supply                       |  |                            | .01               |                   |                   | *   | *   | pA/V             |
| OFFSET CURRENT, initial                       |  |                            | 10                | 50                |                   | *   | *   | pA               |
| INPUT IMPEDANCE, DC                           |  |                            | 10 <sup>n</sup>   |                   |                   | *   | *   | $\Omega$         |
| INPUT CAPACITANCE                             |  |                            | 13                |                   |                   | *   | *   | pF               |
| COMMON MODE VOLTAGE RANGE                     | Full temperature range   | $-V_B + 12$<br>$+V_B - 14$ |                   |                   | *                 |     |     | V                |
| COMMON MODE REJECTION, DC                     | Full temp, range, $V_{CM} = \pm 20V$   | 90                         | 100               |                   | *                 | *   | *   | dB               |
| INPUT NOISE                                   | 100KHZ BW, $R_S = 1K\Omega$  |                            | 10                |                   |                   | *   | *   | $\mu V_{rms}$    |
| <b>GAIN</b>                                   |  |                            |                   |                   |                   |     |     |                  |
| OPEN LOOP, @ 15Hz                             | Full temperature range   | 94                         | 102               |                   | *                 | *   | *   | dB               |
| GAIN BANDWIDTH PRODUCT                        | $R_L = 10\Omega$   |                            | 3                 |                   |                   | *   | *   | MHz              |
| POWER BANDWIDTH                               | $R_L = 4\Omega$ , $V_o = 180V_{P-P}$ , $A_v = -10$<br>Full temperature range |                            | 90                |                   |                   | *   | *   | kHz              |
| <b>OUTPUT</b>                                 |  |                            |                   |                   |                   |     |     |                  |
| VOLTAGE SWING                                 | $I_o = 40A$  | $\pm V_S \mp 9.5$          | $\pm V_S \mp 8.0$ |                   | *                 | *   | *   | V                |
| VOLTAGE SWING, PA52                           | $\pm V_{BOOST} = \pm V_S \pm 10V$ , $I_o = 40A$                              | $\pm V_S \mp 5.8$          | $\pm V_S \mp 4.0$ |                   |                   |     |     | V                |
| VOLTAGE SWING, PA52A                          | $\pm V_{BOOST} = \pm V_S \pm 10V$ , $I_o = 50A$                              |                            |                   | $\pm V_S \mp 5.8$ | $\pm V_S \mp 5.0$ |     |     | V                |
| CURRENT, peak                                 | 3ms 10% Duty Cycle   | 80                         |                   |                   | *                 | *   | *   | A                |
| SETTLING TIME TO 0.1%                         | $A_v = -10$ , 10V STEP, $R_L = 4\Omega$                                      |                            | 1                 |                   |                   | *   | *   | $\mu s$          |
| SLEW RATE                                     | $A_v = -10$  | 50                         |                   |                   | *                 | *   | *   | V/ $\mu s$       |
| RESISTANCE                                    | $I_o = 0$ , NO LOAD, 2MHZ  |                            | 2.5               |                   |                   | *   | *   | $\Omega$         |
| <b>POWER SUPPLY</b>                           |  |                            |                   |                   |                   |     |     |                  |
| VOLTAGE, $\pm V_{BOOST}$                      | Full temperature range   | +14, -12                   | $\pm 30$          | $\pm 115$         | *                 | *   | *   | V                |
| VOLTAGE, $\pm V_S$                            | Full temperature range   | $\pm 3$                    |                   | $\pm 100$         | *                 | *   | *   | V                |
| CURRENT, quiescent, boost supply              |  |                            | 26                | 32                |                   | *   | *   | mA               |
| CURRENT, quiescent, total                     |  |                            | 30                | 36                |                   | *   | *   | mA               |
| <b>THERMAL</b>                                |  |                            |                   |                   |                   |     |     |                  |
| RESISTANCE, AC, junction to case <sup>3</sup> | Full temperature range, $F > 60HZ$   |                            | .2                | .25               |                   | *   | *   | $^\circ C/W$     |
| RESISTANCE, DC, junction to case              | Full temperature range, $F > 60HZ$   |                            | .25               | .31               |                   | *   | *   | $^\circ C/W$     |
| RESISTANCE, junction to air                   | Full temperature range   |                            | 12                |                   |                   | *   | *   | $^\circ C/W$     |
| TEMPERATURE RANGE, case                       | Meets full range specification   | -25                        |                   | 85                | *                 |     | *   | $^\circ C$       |

NOTES: \* The specification of PA52A is identical to the specification for PA52 in applicable column to the left

- Unless otherwise noted:  $T_c = 25^\circ C$ , DC input specifications are  $\pm$  value given. Power supply voltage is typical rating.  
 $\pm V_{BOOST} = \pm V_S$ .
- Long term operation at the maximum junction temperature will result in reduced product life. Derate internal power dissipation to achieve high MTTF. For guidance, refer to the heatsink data sheet.
- Rating applies if the output current alternates between both output transistors at a rate faster than 60 Hz.

### CAUTION

The PA52 is constructed from MOSFET transistors. ESD handling procedures must be observed.

The internal substrate contains beryllia (BeO). Do not break the seal. If accidentally broken, do not crush, machine, or subject to temperatures in excess of 850°C to avoid generating toxic fumes.

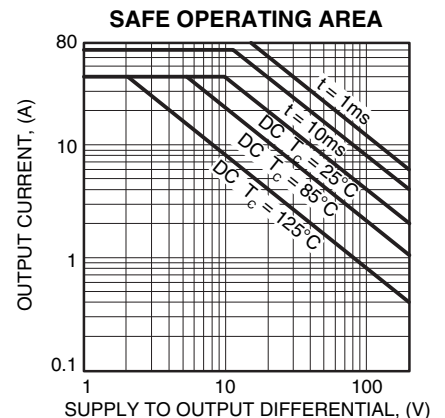
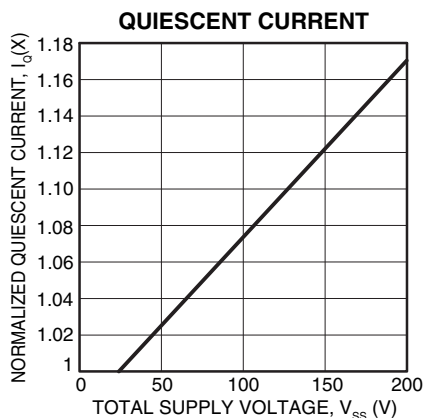
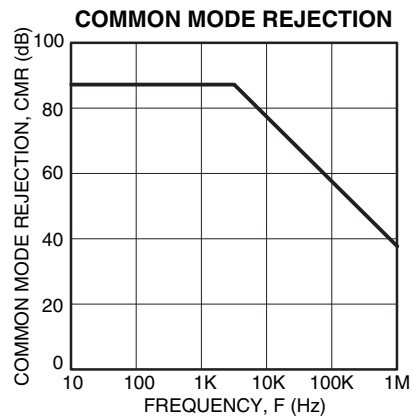
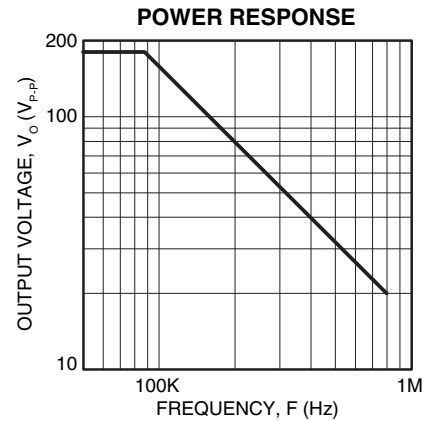
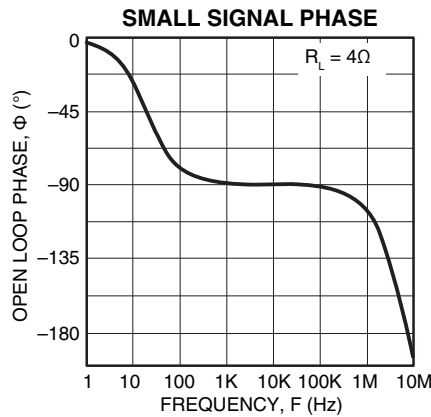
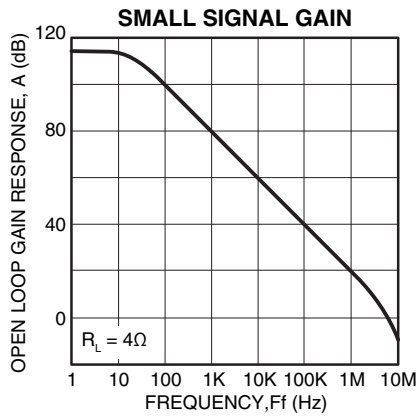
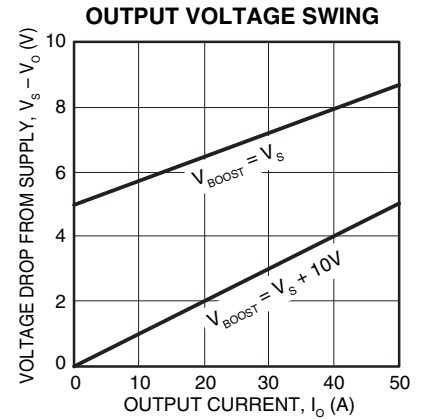
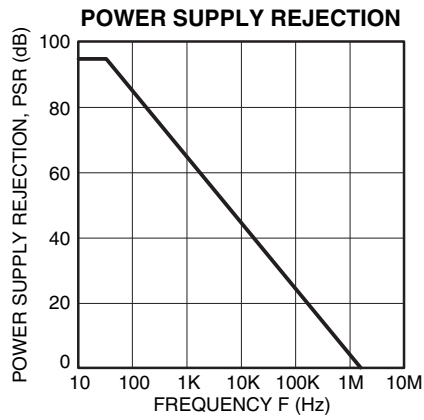
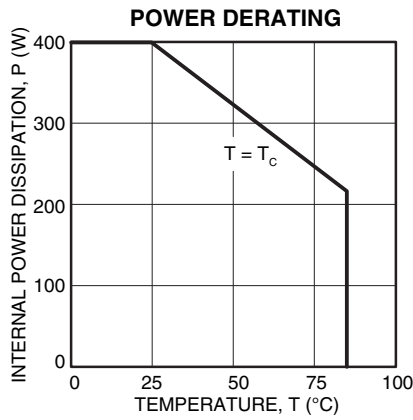

## GENERAL

Please read Application Note 1 "General Operating Considerations" which covers stability, supplies, heat sinking, mounting, current limit, SOA interpretation, and specification interpretation. Visit [www.apexmicrotech.com](http://www.apexmicrotech.com) for design tools that help automate tasks such as calculations for stability, internal power dissipation, current limit; heat sink selection; Apex's complete Application Notes library; Technical Seminar Workbook; and Evaluation Kits.

## CURRENT LIMIT

There is no internal circuit provision for current limit in the PA52. However, the PA52 circuit board in the PA52 evaluation kit does provide a means whereby the output current can be sensed. An external circuit current limit can thereby be implemented if needed.

## BOOST OPERATION

With the  $V_{\text{BOOST}}$  feature the small signal stages of the amplifier are operated at higher supply voltages than the amplifier's high current output stage.  $+V_{\text{BOOST}}$  (pin 11) and  $-V_{\text{BOOST}}$  (pin 12) are connected to the small signal circuitry of the amplifier.  $+V_{\text{S}}$  (pin 9,10) and  $-V_{\text{S}}$  (pin 3,4) are connected to the high current output stage. An additional 10V on the  $V_{\text{BOOST}}$  pins is sufficient to allow the small signal stages to drive the output transistors into saturation and improve the output voltage swing for extra efficient operation when required. When close swings to the supply rails is not required the  $+V_{\text{BOOST}}$  and  $+V_{\text{S}}$  pins must be strapped together as well as the  $-V_{\text{BOOST}}$  and  $-V_{\text{S}}$  pins. The boost voltage pins must not be at a voltage lower than the  $V_{\text{S}}$  pins.

## COMPENSATION

Compensation is internally fixed for a gain of 3 or more and is not adjustable by the user. The PA52 therefore is not unity gain stable.

## POWER SUPPLY BYPASSING

Proper and sufficient power supply bypassing is crucial to proper operation of the PA52. Bypass the  $+V_{\text{b}}$  and  $-V_{\text{b}}$  supply pins with a minimum  $.1\mu\text{F}$  ceramic capacitors directly at the supply pins. On the  $+V_{\text{s}}$  and  $-V_{\text{s}}$  pins use a combination of ceramic and electrolytic capacitors. Use  $1\mu\text{F}$  ceramic capacitors and an electrolytic capacitor at least  $10\mu\text{F}$  for each amp of output current required.